

Product Description

The TGA2227–SM is a packaged, low noise amplifier offering high electrical performance, along with exceptional robustness to incident power. Fabricated on Qorvo’s 0.15 um GaN on SiC production process (QGaN15), the TGA2227–SM operates over 2–22 GHz and delivers >15 dB small signal gain and >+22 dBm P1dB while supporting 2 dB mid-band Noise Figure.

Robustness to incident power levels of up to 10 Watts is an industry first for a low noise MMIC amplifier and cannot be achieved in competing technologies. This supports potential system cost savings and board area reduction by removal of receive protection circuitry. This would also improve system-level noise figure.

The TGA2227–SM is an ideal choice for radar and EW applications as well as high power communication systems and test and measurement across commercial and military markets.

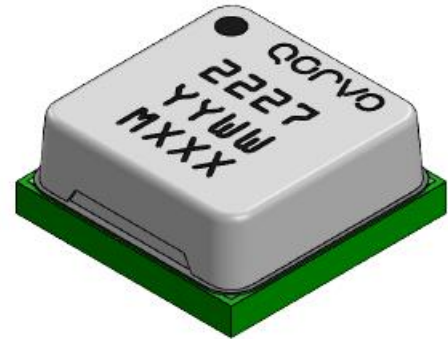

Product Features

- List Frequency Range: 2 – 22 GHz
- High Input Power Survivability: 40 dBm
- Noise Figure: 2.0 dB (mid–band)
- Gain > 15 dB
- IM3: –36.5 dBc ($P_{IN}/\text{tone} = -4 \text{ dBm}$, $\Delta f = 10 \text{ MHz}$)
- P1dB > +22 dBm
- Bias: $V_D = +8 \text{ V}$, $I_{DQ} = 125 \text{ mA}$
- Operating Drain Voltage Range: +5 to +15 V
- Package Dimensions: 4.0 mm x 4.0 mm x 1.7 mm

Applications

- Commercial & Military Communications
- Commercial & Military Radar
- Electronic Warfare
- Instrumentation
- LNA, Driver, Gain Block, General Amplification

Functional Block Diagram

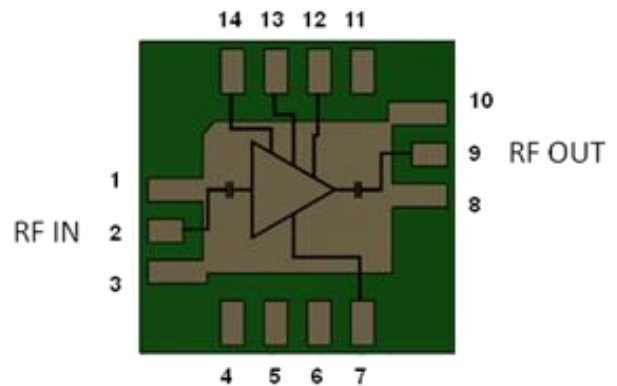

Ordering Information

Part No.	Description
TGA2227-SM	GaN LNA, Waffle Pack, Qty 25
TGA2227-SMTR7	Tape & Reel, 7", Qty 500
TGA2227-SMEVB02	TGA2227-SM Evaluation Board, Qty 1

Recommended Operating Conditions

Parameter	Min	Typ	Max	Units
Drain Voltage (V_D), Low Pdiss Bias	+5	+8	+20	V
Drain Voltage (V_D), Power Bias	–	+15	–	V
Quiescent Drain Current (I_{DQ})	–	125	–	mA
Gate Voltage (V_G)	–	-2.5	–	V
Cascode Voltage (V_C), Low Pdiss Bias	–	+2	–	V
Cascode Voltage (V_C), Power Bias	–	+4	–	V
Operating Temperature Range	-40	–	+85	°C

Electrical performance is measured under conditions noted in the electrical specifications table. Specifications are not guaranteed over all recommended operating conditions.

Electrical Specifications – Low P_{diss} Bias

Test conditions unless otherwise noted: T_{BASE} = +25 °C, V_D = +8 V, V_C = +2 V
Data de-embedded to device reference planes

Parameter	Conditions	Min	Typ	Max	Units
Operational Frequency Range		2	–	22	GHz
Small Signal Gain	2 GHz to 20 GHz	–	15.7	–	dB
Small Signal Gain	2 GHz	15	15.7	19	dB
Small Signal Gain	2 GHz to 19 GHz	13.5	15.7	19	dB
Small Signal Gain	19 GHz to 20 GHz	12.8	15.7	19	dB
Noise Figure	2 GHz to 20 GHz	–	2.6	–	dB
Noise Figure	2 GHz to 5 GHz	–	2.6	4.2	dB
Noise Figure	5 GHz to 10 GHz	–	2.6	2.7	dB
Noise Figure	10 GHz to 20 GHz	–	2.6	5.0	dB
Input Return Loss		–	10	–	dB
Output Return Loss		–	12	–	dB
P _{SAT}		–	+26.3	–	dBm
P _{1dB}		–	+23.0	–	dBm
IM3	P _{IN} /tone = -4 dBm, Δf = 10 MHz	–	-36.5	–	dBc
S21 Temperature Coefficient		–	-0.024	–	dB/°C
NF Temperature Coefficient		–	0.013	–	dB/°C
Gate Leakage Current	V _D = 10 V, V _G = - 3.7V, V _C = 2V	-1.28		0	mA

Electrical Specifications – Power Bias

Test conditions unless otherwise noted: T_{BASE} = +25 °C, V_D = +15 V, V_C = +4 V
Data de-embedded to device reference planes

Parameter	Conditions	Min	Typ	Max	Units
Operational Frequency Range		2	–	22	GHz
Small Signal Gain		–	15.7	–	dB
Noise Figure		–	2.7	–	dB
Input Return Loss		–	10	–	dB
Output Return Loss		–	12	–	dB
P _{SAT}	P _{IN} = +14 dBm	–	27.9	–	dBm
P _{1dB}		–	25.4	–	dBm
IM3	P _{IN} /tone = -4 dBm, Δf = 10 MHz	–	-41.8	–	dBc
S21 Temperature Coefficient		–	-0.025	–	dB/°C
NF Temperature Coefficient		–	0.012	–	dB/°C
Gate Leakage Current	V _D = 10 V, V _G = - 3.7V, V _C = 2V	-1.28		0	mA

Absolute Maximum Ratings

Parameter	Range / Value	Units
Drain Voltage (V_D)	+29.5	V
Cascode Voltage (V_C)	$V_C < V_D$ and $V_C < +9$	V
Drain Current (I_D)	300	mA
Gate Voltage (V_G)	-5 to 0	V
Gate Current (I_G)	See graph	–
RF Input Power (25 °C, 50 Ω)	+40	dBm
Mounting Temperature (30 seconds maximum)	+260	°C
Storage Temperature	-55 to +150	°C

Operation of this device outside the parameter ranges given above may cause permanent damage. These are stress ratings only, and functional operation of the device at these conditions is not implied. Extended application of Absolute Maximum Rating conditions may reduce device reliability.

Thermal and Reliability Information

Parameter	Values	Units	Conditions
Small Signal, Thermal Resistance (θ_{JC}) ^(1,2,3)	4.62	°C/W	$T_{BASE} = +85\text{ °C}$, $V_D = +8\text{ V}$, $V_C = +2.0\text{ V}$ $V_G = -2.4\text{ V}$, $I_{D_DRIVE} = 125\text{ mA}$ $P_{IN} = -10\text{ dBm}$, $P_{OUT} = +6\text{ dBm}$, $P_{DISS} = 1.00\text{ W}$
Channel Temperature (T_{CH})	89.62	°C	
Small Signal, Thermal Resistance (θ_{JC}) ^(1,2,3)	6.07	°C/W	$T_{BASE} = 85\text{ °C}$, $V_D = +15\text{ V}$, $V_C = +4.0\text{ V}$ $V_G = -2.4\text{ V}$, $I_{D_DRIVE} = 125\text{ mA}$ $P_{IN} = -10\text{ dBm}$, $P_{OUT} = +6\text{ dBm}$, $P_{DISS} = 1.88\text{ W}$
Channel Temperature (T_{CH})	96.39	°C	
Under Drive, Thermal Resistance (θ_{JC}) ^(1,2,3)	6.32	°C/W	$T_{BASE} = 85\text{ °C}$, $V_D = +15\text{ V}$, $V_C = +4.0\text{ V}$ $V_G = -2.4\text{ V}$, $I_{D_DRIVE} = 197\text{ mA}$ $P_{IN} = +16\text{ dBm}$, $P_{OUT} = +28.4\text{ dBm}$, $P_{DISS} = 2.30\text{ W}$
Channel Temperature (T_{CH})	99.56	°C	

Notes:

1. Thermal resistance is measured to package backside
2. Base or ambient temperature is 85 °C
3. Refer to the following document: [GaN Device Channel Temperature, Thermal Resistance, and Reliability Estimates](#)

Performance Plots – Small Signal

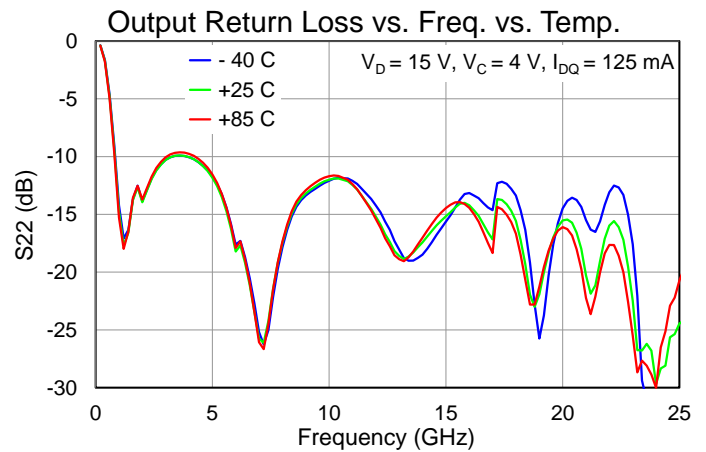
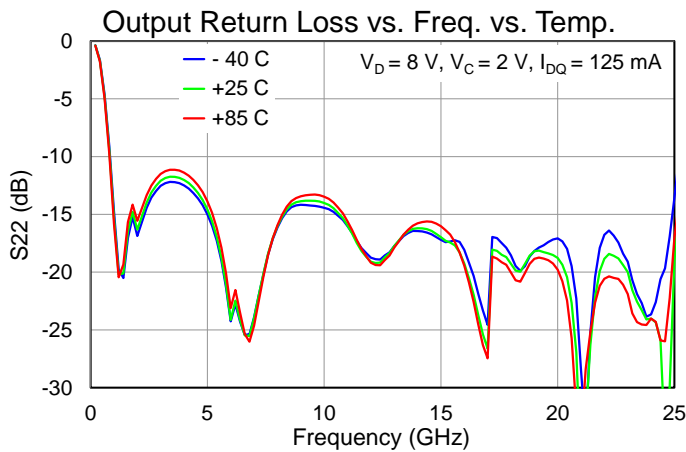
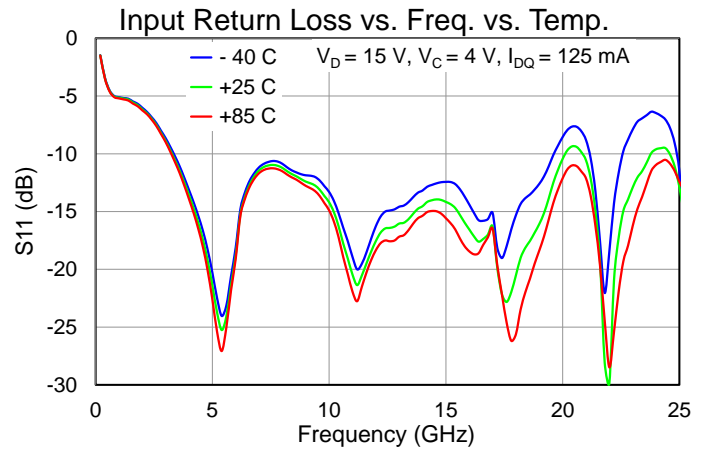
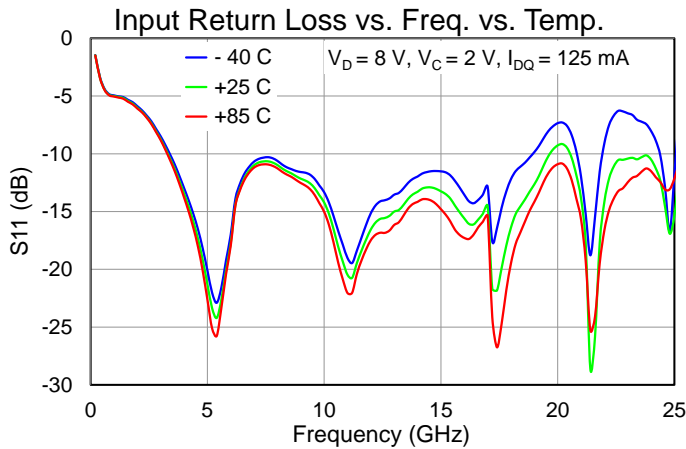
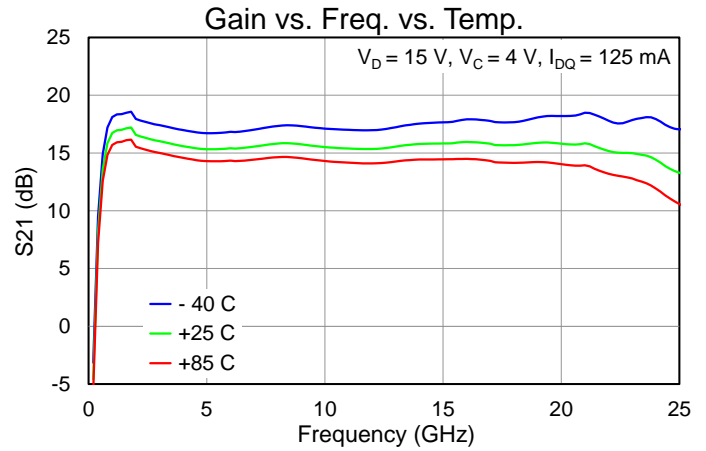
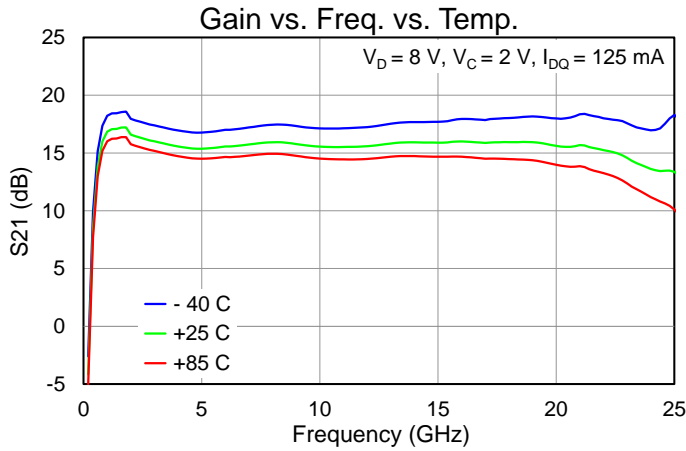

Performance Plots – Small Signal

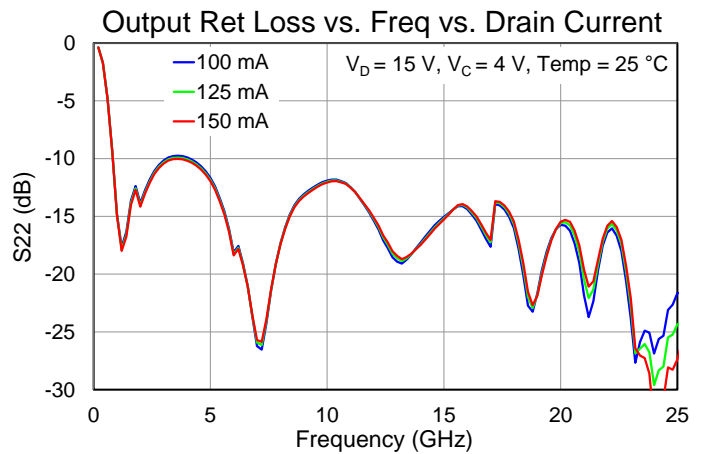
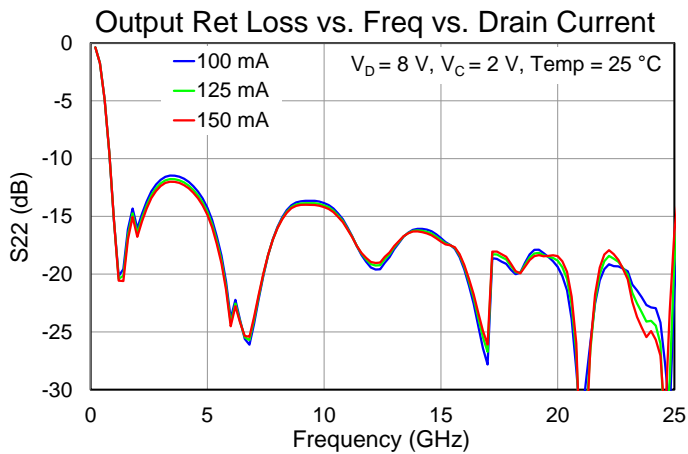
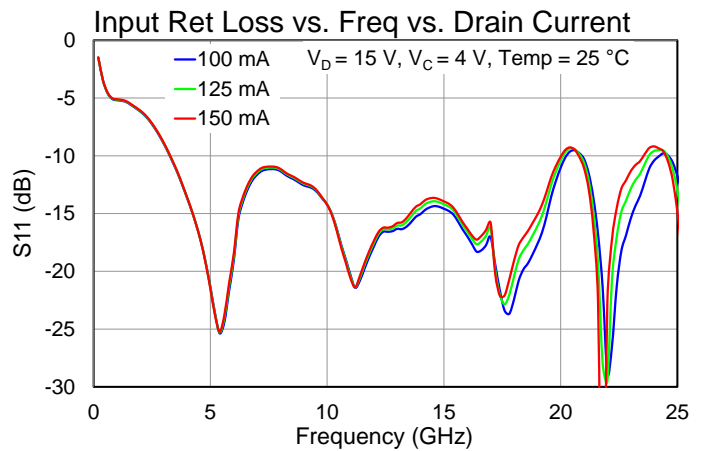
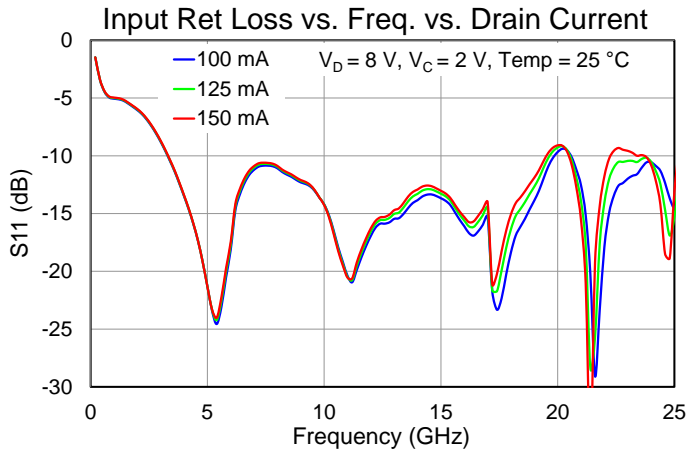
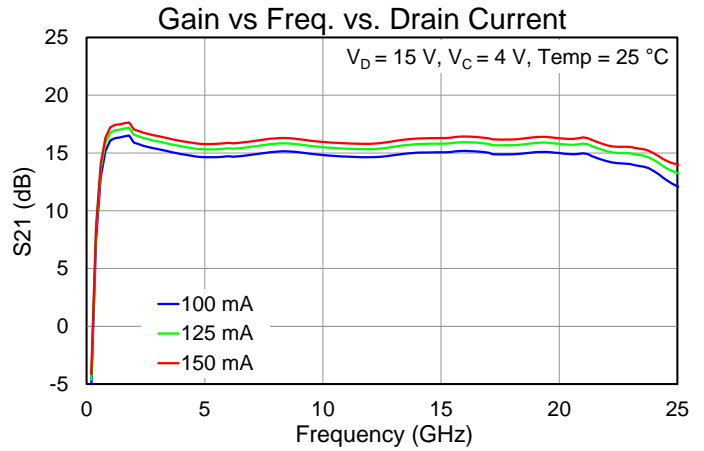
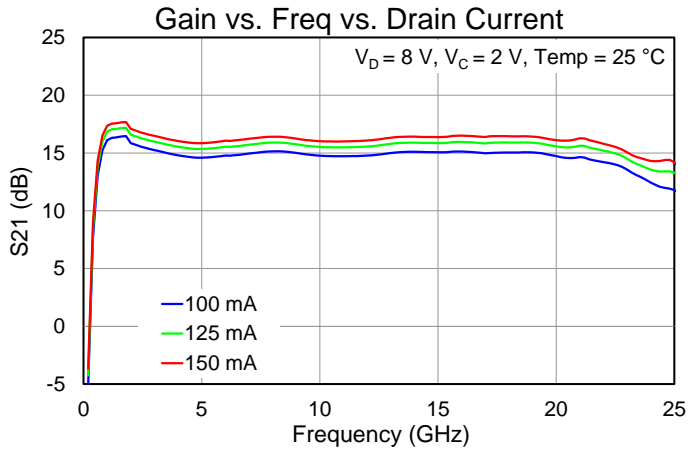

Performance Plots – Noise Figure

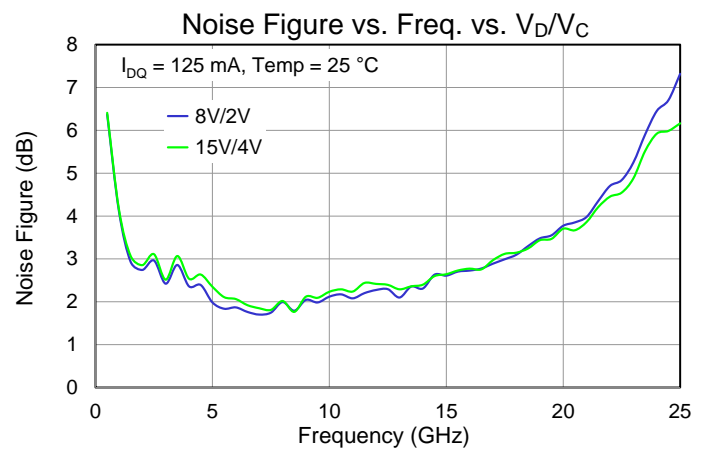
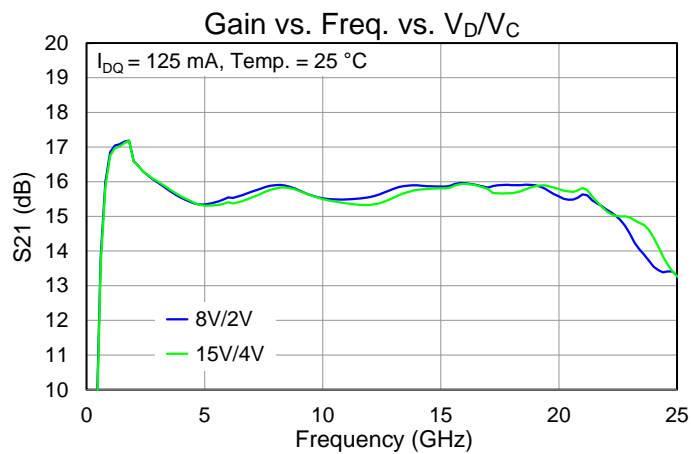
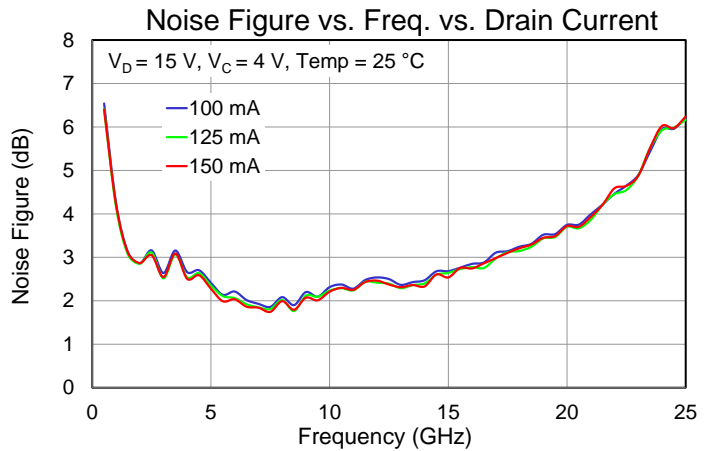
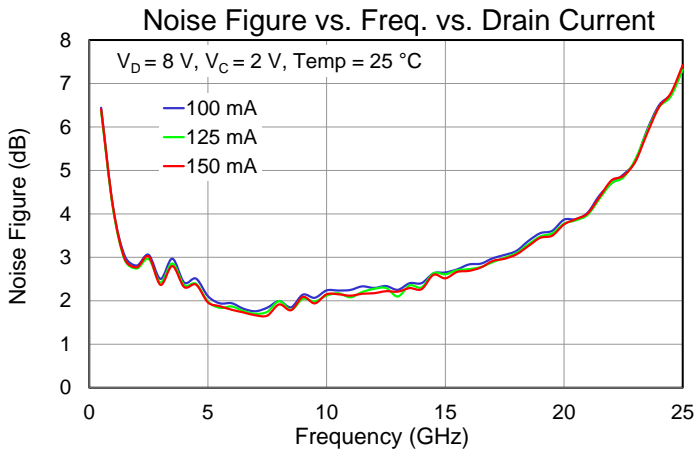
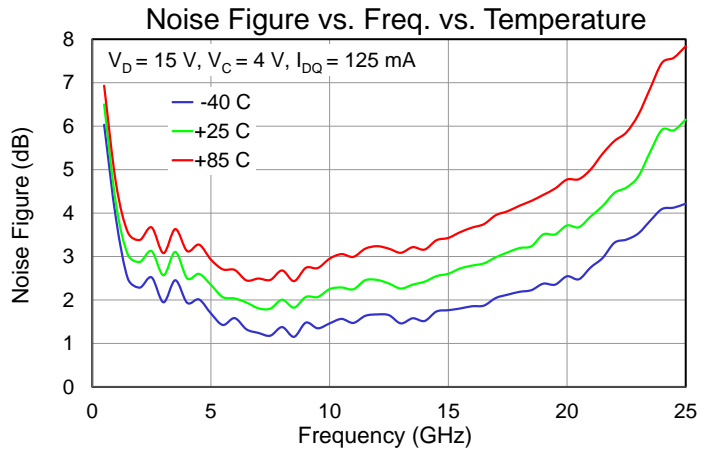
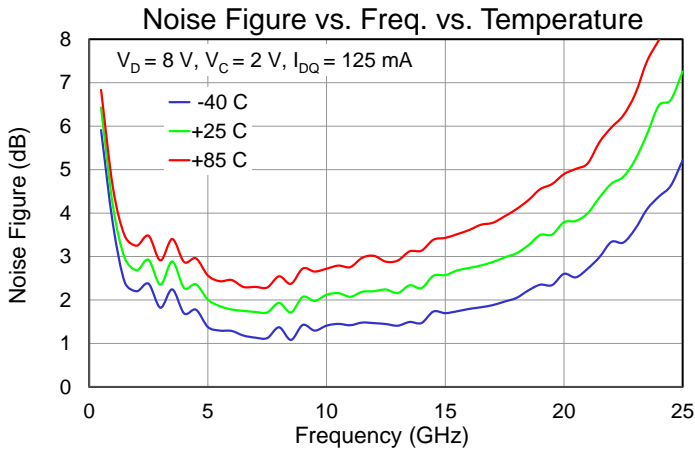

Performance Plots – Large Signal

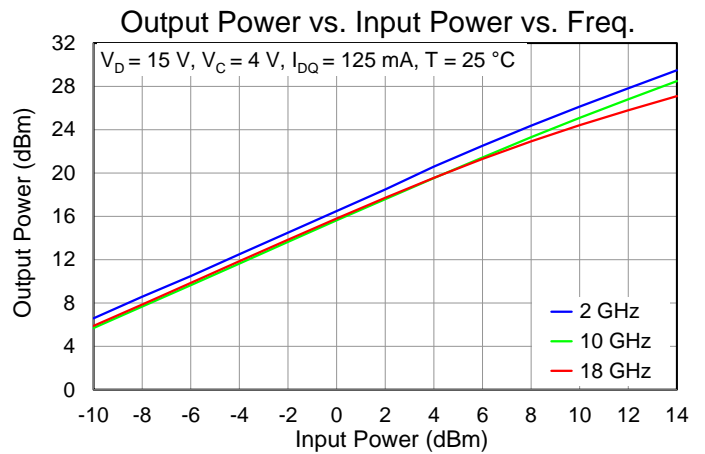
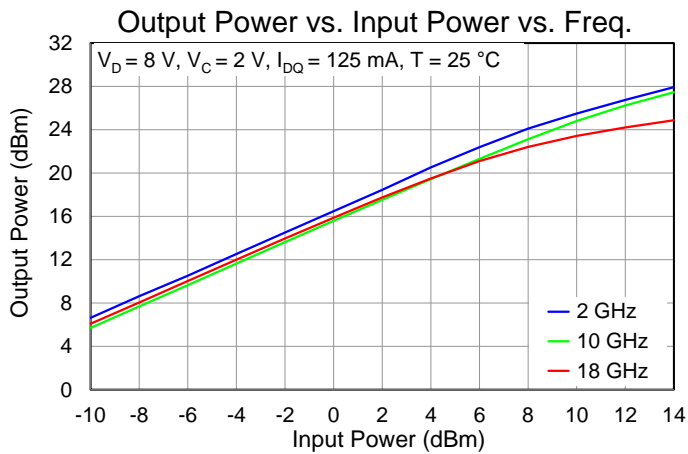
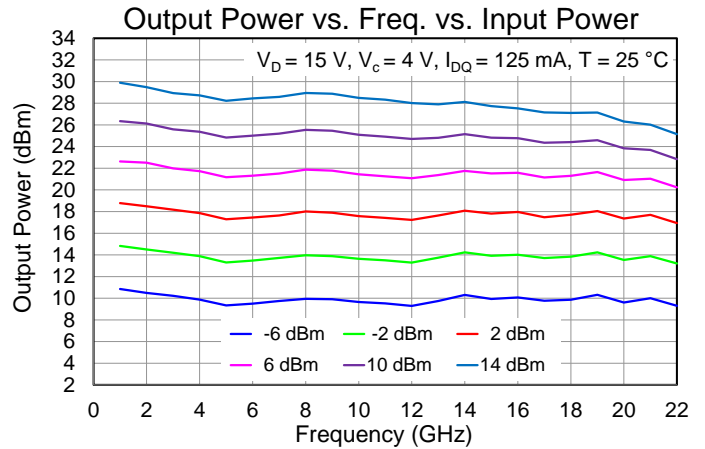
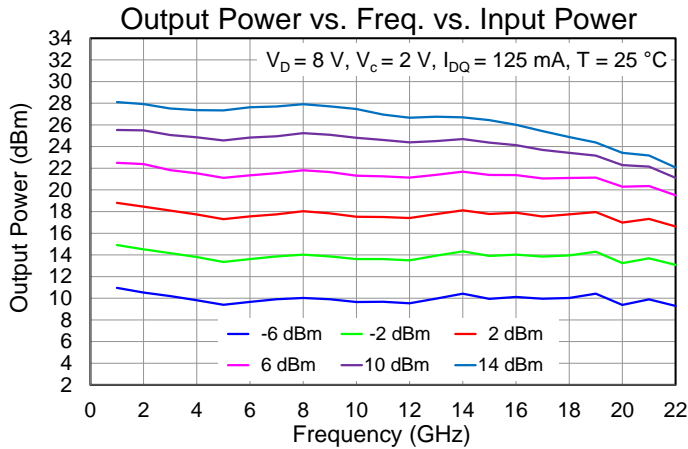
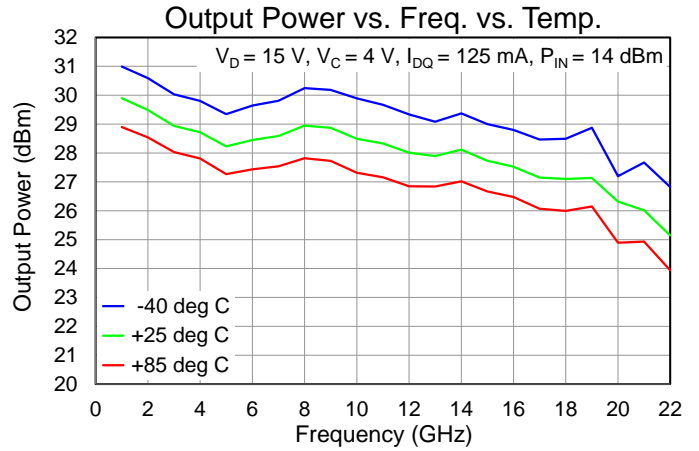
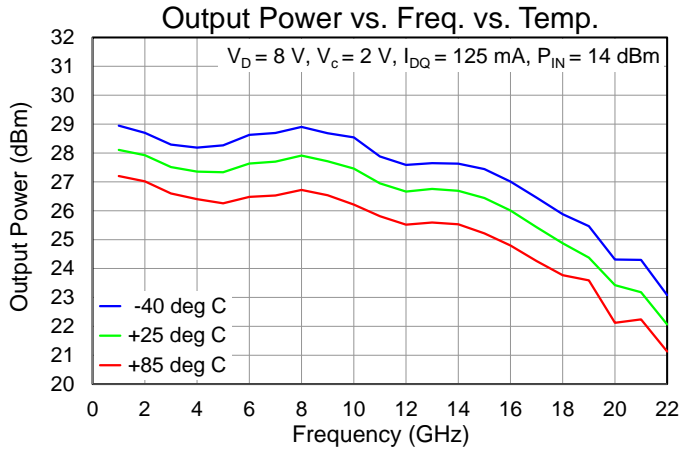

Performance Plots – Large Signal

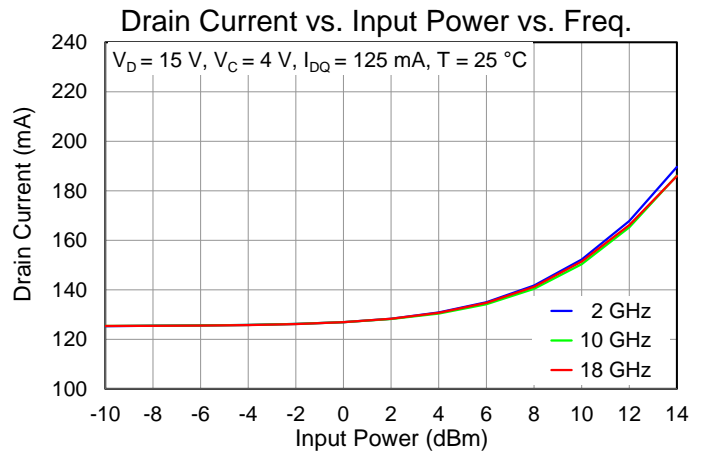
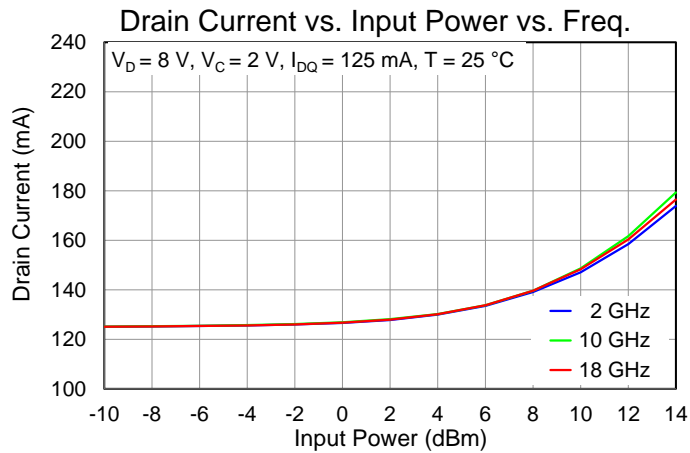
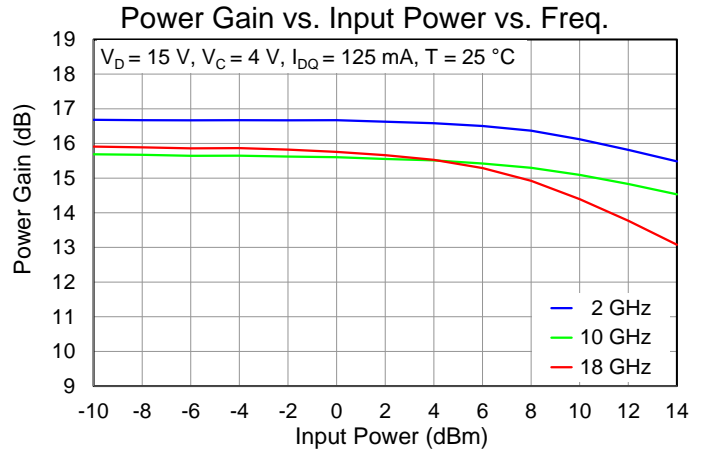
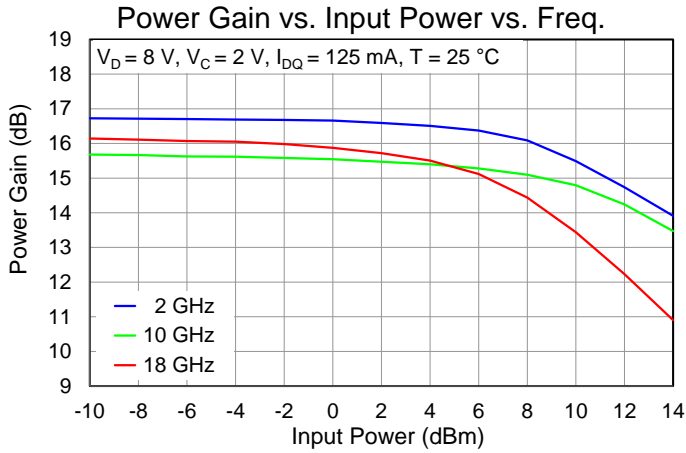

Performance Plots – Linearity

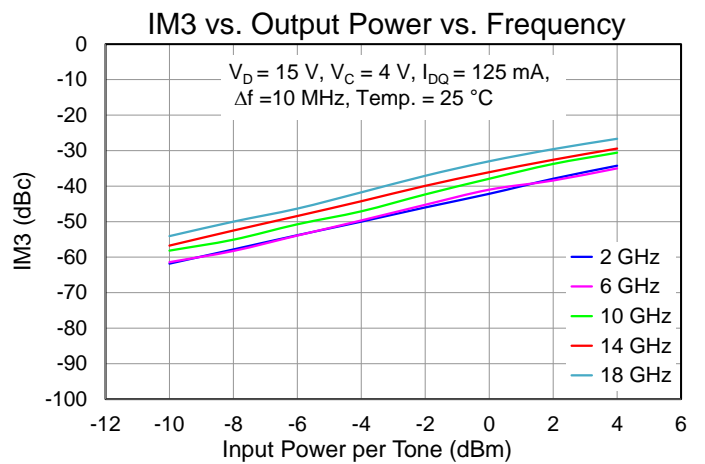
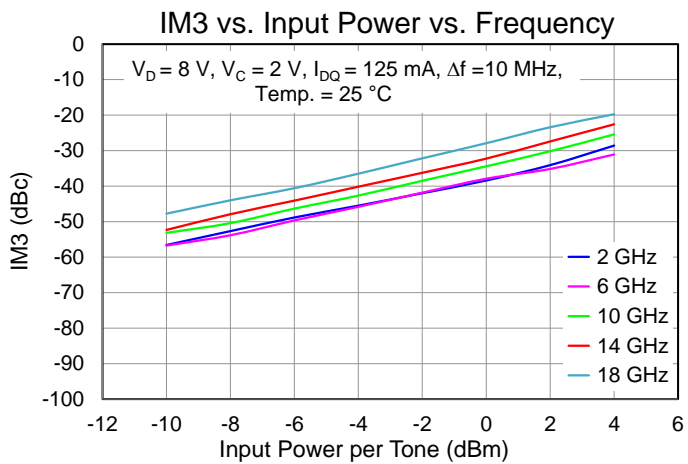
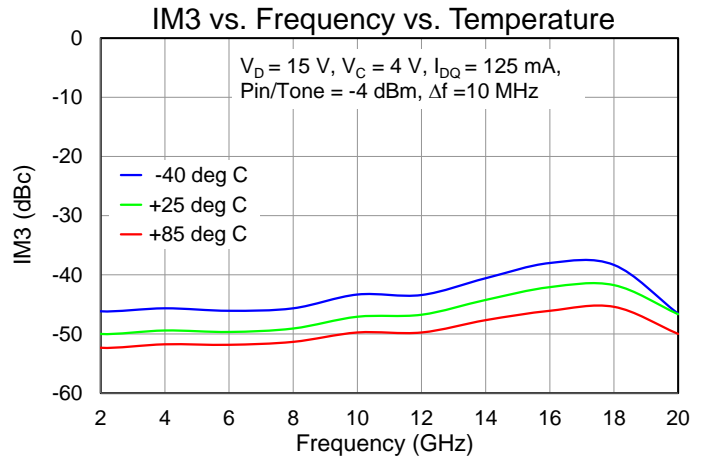
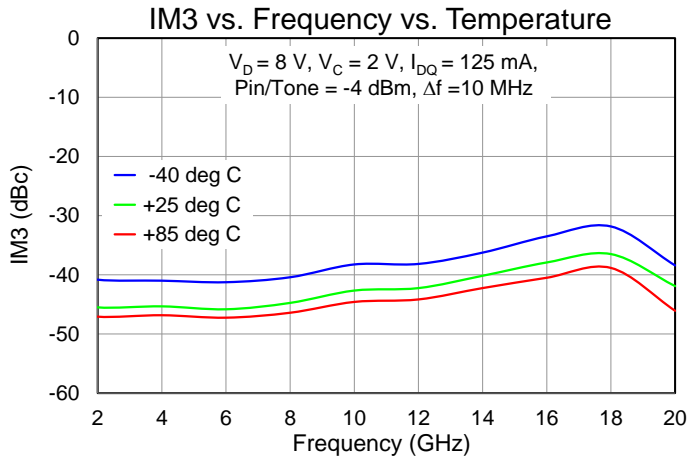

Performance Plots – Linearity

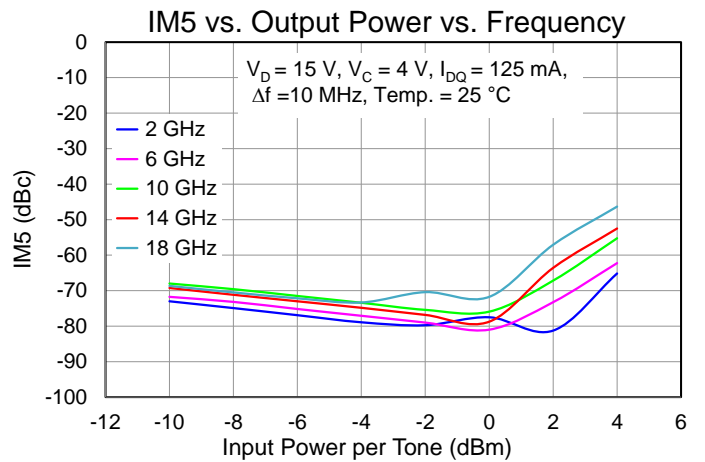
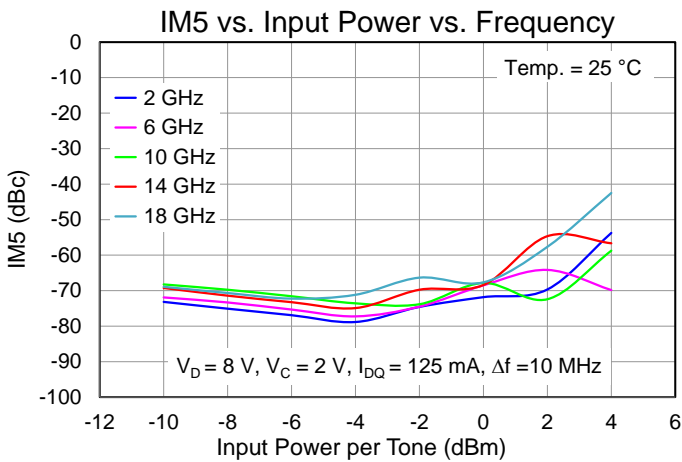
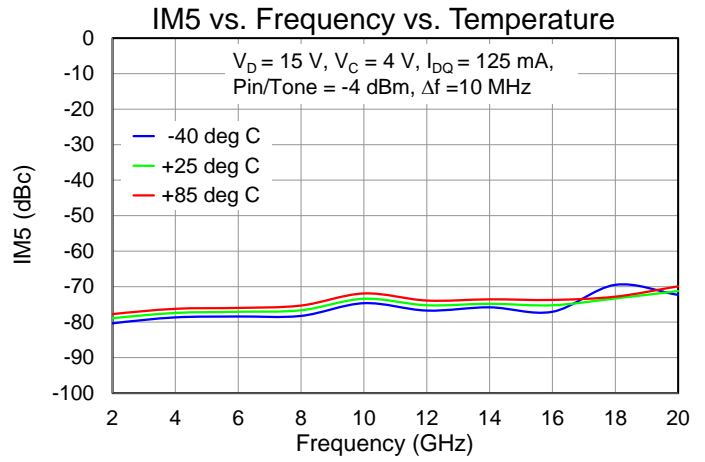
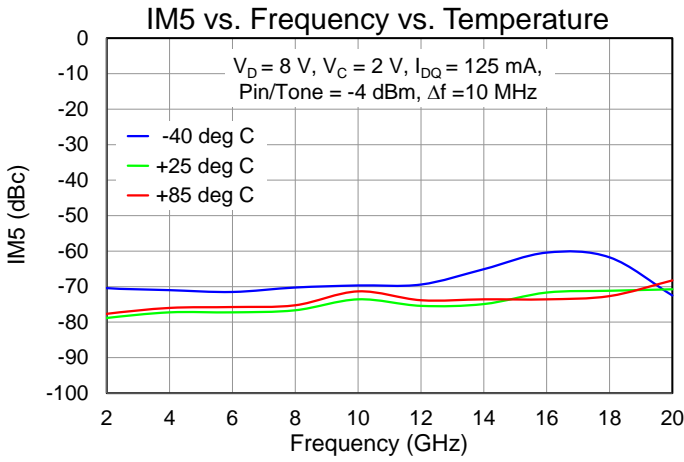

Application Circuit

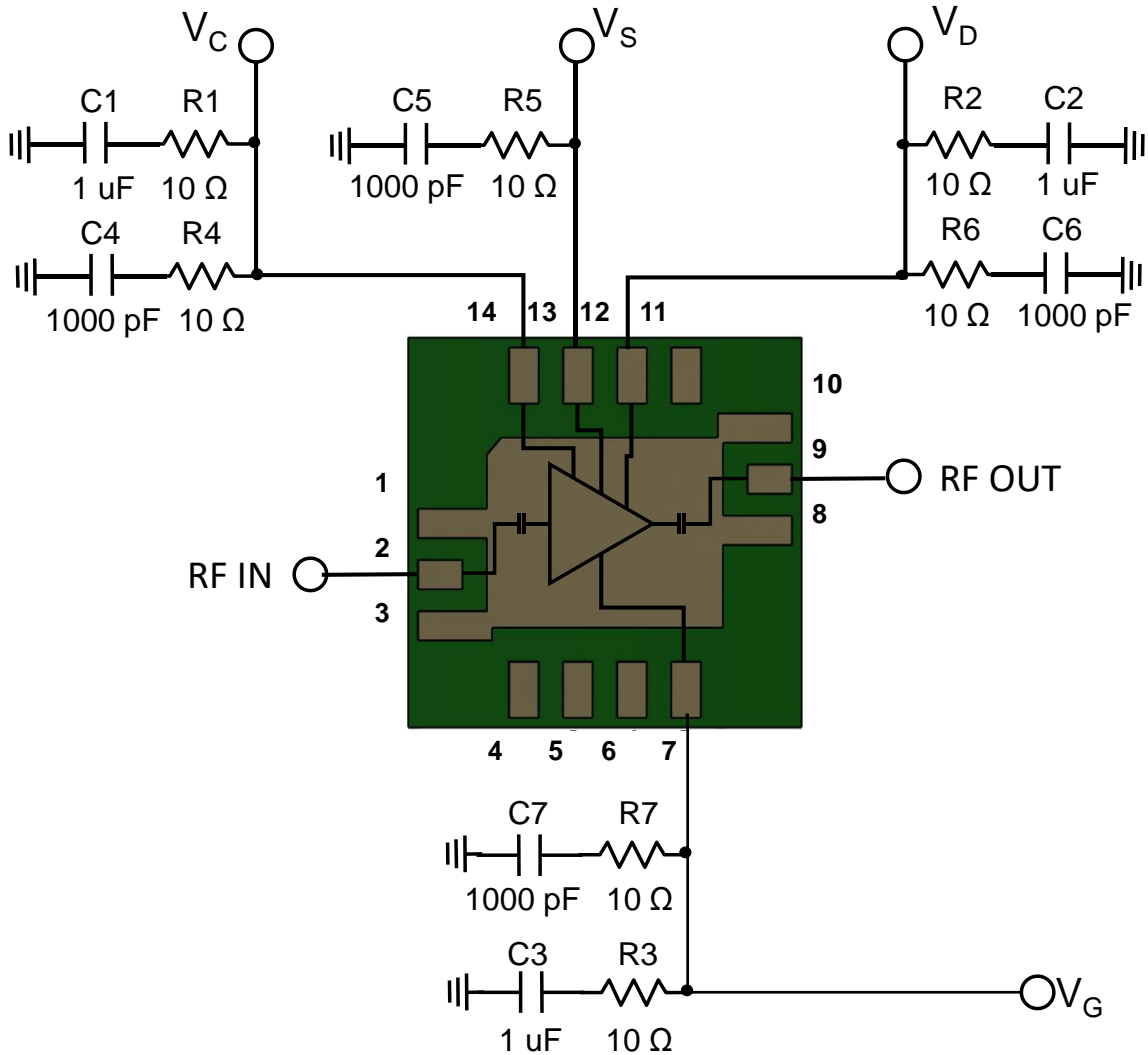

Bias Up Procedure

1. Set $V_G = -5.0\text{ V}$, $V_C = 0.0\text{ V}$, $V_D = 0.0\text{ V}$
2. Adjust V_D to desired drain voltage
3. Adjust V_C to desired voltage
4. Adjust V_G until $I_{DQ} = 125\text{ mA}$
5. Turn on RF signal

Bias Down Procedure

1. Turn off RF signal
2. Adjust V_G to -5.0 V
3. Adjust V_C to 0.0 V
4. Adjust V_D to 0.0 V
5. Adjust V_G to 0.0 V

EVB Part Number or Ref. Design Name

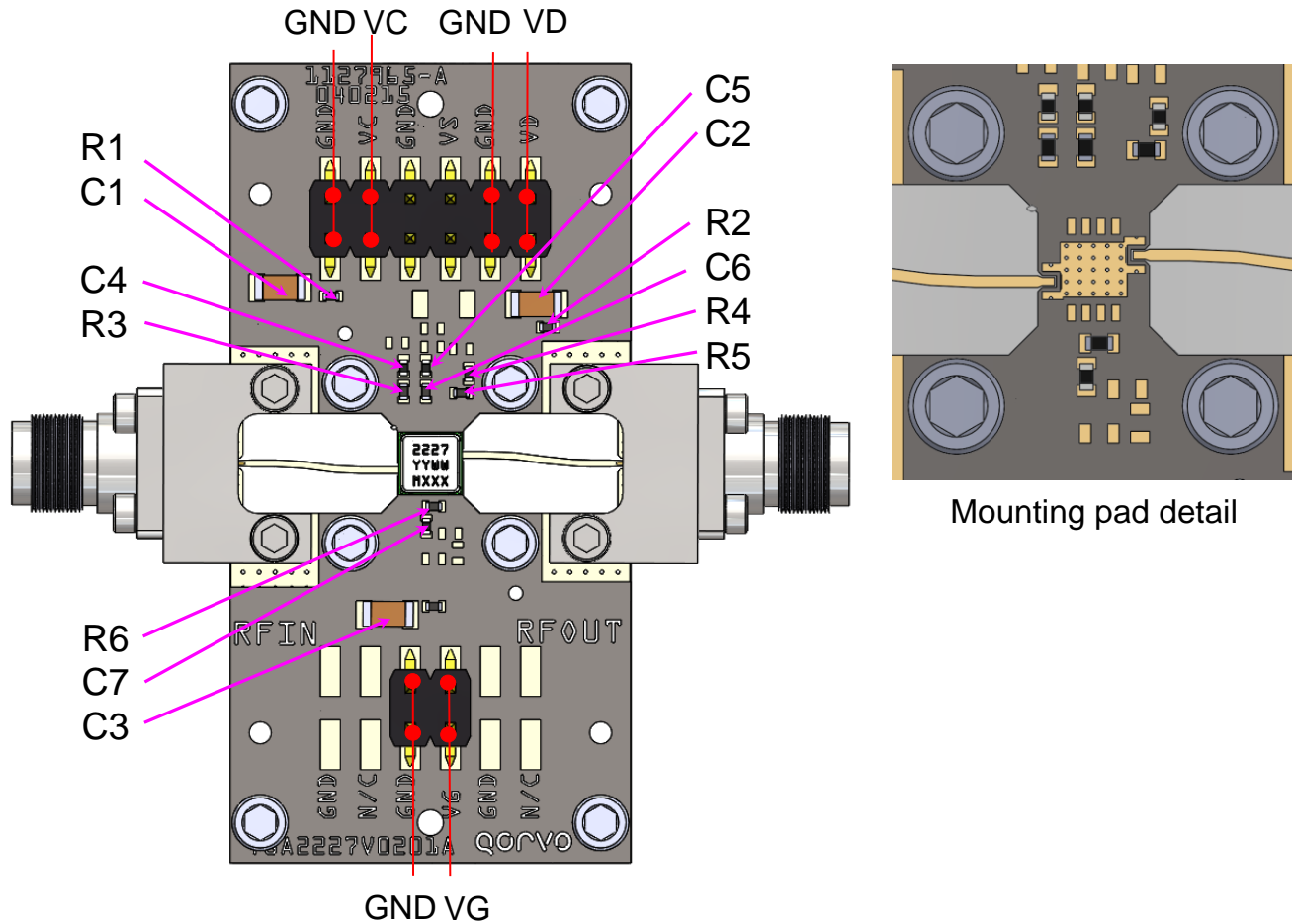

RF Layer is 0.008" thick Rogers Corp. RO4003C, $\epsilon_r = 3.38$. Metal layers are 0.5 oz. copper. The microstrip line at the connector interface is optimized for the Southwest Microwave end launch connector 1092-01A-5.

The trace pattern shown has been developed and tested for optimized assembly at TriQuint Semiconductor. The PCB land pattern has been developed to accommodate lead tolerances. Since processes vary from company to company, careful process development is recommended

Bill of Materials

Reference Des.	Value	Description	Manuf.	Part Number
C1 – C3	1 uF, +50 V, 5 %	CAP X7R 1206	Various	–
C4 – C7	1000 pF, +50 V, 10 %	CAP X7R 0402	Various	–
R1 – R6	10 Ohm, 5 %	RES 0402, SMD	Various	–

Pin Configuration and Description

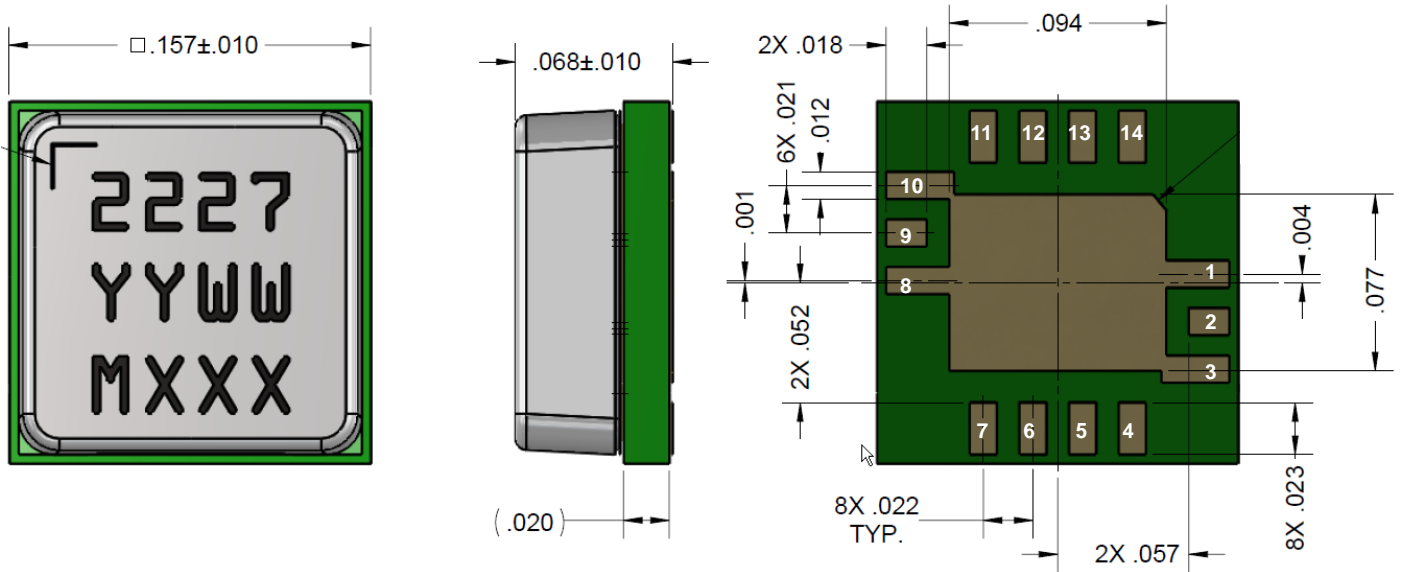

Dimensions in inch. Package lead finish: Ni / Au plating with minimum gold thickness of 0.1 um
 Part Marking: 2227: Part Number, YY = Part Assembly Year, WW = Part Assembly Week, MXXX = Batch ID

Pin No.	Label	Description
1, 3, 8, 10	GND	RF Ground
2	RF Input	RF input pad, DC blocked
4, 5, 6, 11	NC (or GND)	No connection in package; grounding may improve performance
7	VG	Gate voltage
9	RF Output	RF output pad, DC blocked
12	VD	Drain voltage
13	VS	Drain voltage monitor
14	VC	Cascode voltage

Tape and Reel Information

Standard T/R size = 500 pieces on a 7" reel.

Material		Cavity (mm)				Distance Between Centerline (mm)		Carrier Tape (mm)	Cover Carrier (mm)
Vendor	Vendor P/N	Length (A0)	Width (B0)	Depth (K0)	Pitch (P1)	Length direction (P2)	Width Direction (F)	Width (W)	Width (W)
Advantek	BCA014	4.3	4.3	2.1	8.0	2.00	5.50	12.0	9.20

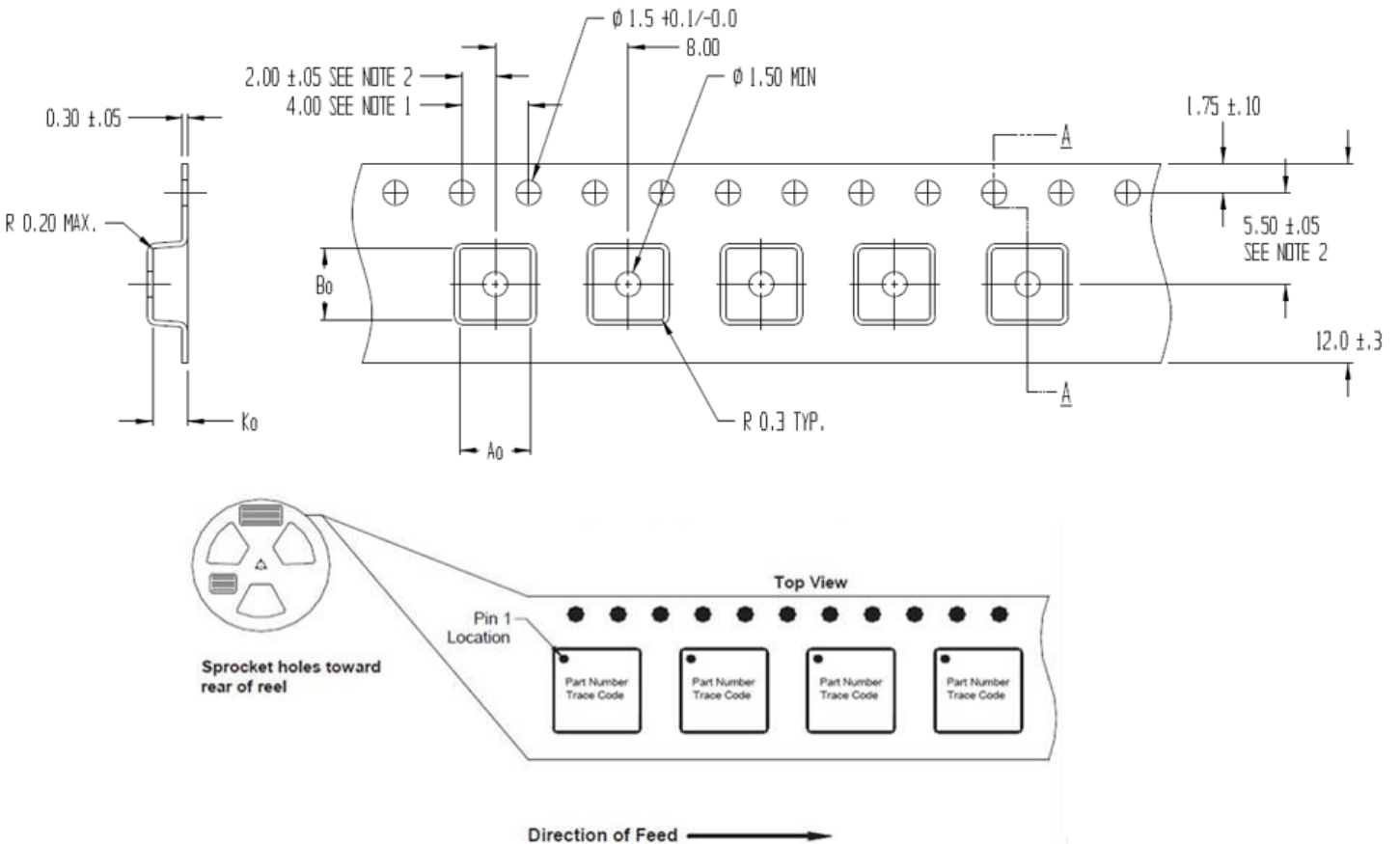

Assembly Notes

Compatible with lead-free soldering processes with 260°C peak reflow temperature.

This package is air-cavity and non-hermetic, and therefore cannot be subjected to aqueous washing. The use of no-clean solder to avoid washing after soldering is highly recommended.

Contact plating: Ni-Au

Solder rework not recommended

Recommended Soldering Temperature Profile

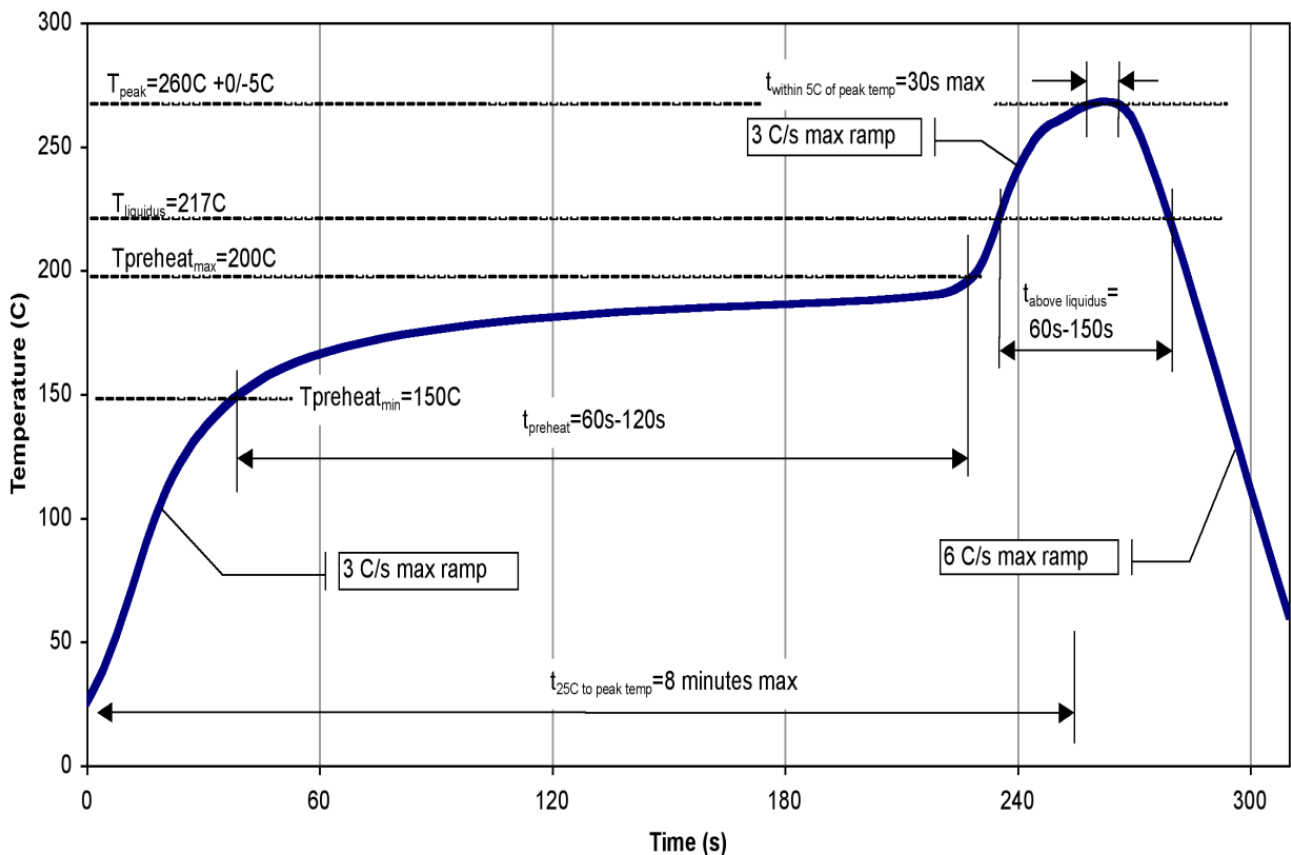

Handling Precautions

Parameter	Rating	Standard
ESD – Human Body Model (HBM)	Class 0B	ESDA / JEDEC JS-001-2012
ESD – Charged Device Model (CDM)	C3	ESDA / JEDEC JS-002-2014
MSL – 260 °C Convection Reflow	Level 3	JEDEC standard IPC/JEDEC-J-STD-020



Caution!
ESD-Sensitive Device

RoHS Compliance

This product is compliant with the 2011/65/EU RoHS directive (Restrictions on the Use of Certain Hazardous Substances in Electrical and Electronic Equipment), as amended by Directive 2015/863/EU. This product also has the following attributes:

- Lead Free
- Halogen Free (Chlorine, Bromine)
- Antimony Free
- TBBP-A (C₁₅H₁₂Br₄O₂) Free

Contact Information

For the latest specifications, additional product information, worldwide sales and distribution locations:

Tel: 1-844-890-8163

Web: www.qorvo.com

Email: customer.support@qorvo.com

Important Notice

The information contained herein is believed to be reliable; however, Qorvo makes no warranties regarding the information contained herein and assumes no responsibility or liability whatsoever for the use of the information contained herein. All information contained herein is subject to change without notice. Customers should obtain and verify the latest relevant information before placing orders for Qorvo products. The information contained herein or any use of such information does not grant, explicitly or implicitly, to any party any patent rights, licenses, or any other intellectual property rights, whether with regard to such information itself or anything described by such information. **THIS INFORMATION DOES NOT CONSTITUTE A WARRANTY WITH RESPECT TO THE PRODUCTS DESCRIBED HEREIN, AND QORVO HEREBY DISCLAIMS ANY AND ALL WARRANTIES WITH RESPECT TO SUCH PRODUCTS WHETHER EXPRESS OR IMPLIED BY LAW, COURSE OF DEALING, COURSE OF PERFORMANCE, USAGE OF TRADE OR OTHERWISE, INCLUDING THE IMPLIED WARRANTIES OF MERCHANTABILITY AND FITNESS FOR A PARTICULAR PURPOSE.**

Without limiting the generality of the foregoing, Qorvo products are not warranted or authorized for use as critical components in medical, life-saving, or life-sustaining applications, or other applications where a failure would reasonably be expected to cause severe personal injury or death.

Copyright 2020 © Qorvo, Inc. | Qorvo is a registered trademark of Qorvo, Inc.

Mouser Electronics

Authorized Distributor

Click to View Pricing, Inventory, Delivery & Lifecycle Information:

[Qorvo:](#)

[TGA2227-SM](#) [TGA2227-SMEVB02](#)